

ISO-5294

Fekerman supply L, H, XH timing pulleys
 Pulleys bore type:
 Stock bore / Prepare bore

Material selection:
 Steel C45 / Aluminum
 Surface treatment:
 Black oxide, Anodizing, Chromium plating.

Fekerman accept custom made pulleys as per the drawings and technology requirement.

Type L H XH

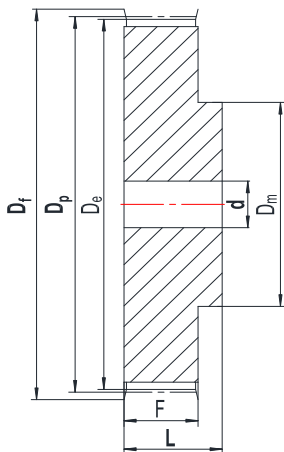
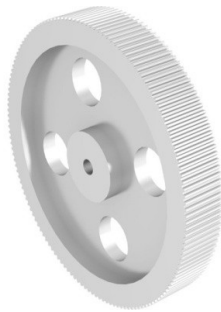

(2F)

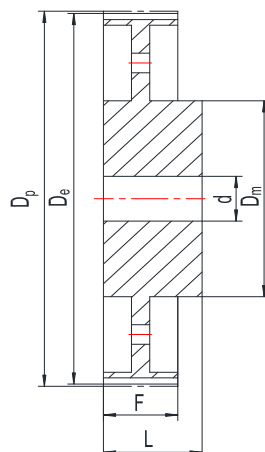

(4)

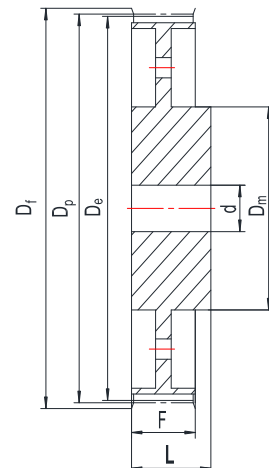

(4F)

Pulleys L050/L075 -Pilot Bore



L050

L-3/8" Pitch

L 050 for belt width 1/2"

Part No.	Type	Mat.	Z	Dp	De	Df	Dm	F	L	d
12 L 050	2F	St	12	36.38	35.62	42	24	19	30	8
13 L 050	2F	St	13	39.41	38.65	44	28	19	30	8
14 L 050	2F	St	14	42.44	41.68	48	28	19	30	8
15 L 050	2F	St	15	45.48	44.72	51	34	19	30	8
16 L 050	2F	St	16	48.51	47.75	54	36	19	32	8
17 L 050	2F	St	17	51.54	50.78	57	36	19	32	10
18 L 050	2F	St	18	54.57	53.81	60	40	19	32	10
19 L 050	2F	St	19	57.61	56.84	63	40	19	32	10
20 L 050	2F	St	20	60.64	59.88	66	40	19	32	10
21 L 050	2F	St	21	63.67	62.91	71	45	19	32	10
22 L 050	2F	St	22	66.70	65.94	75	45	19	32	10
23 L 050	2F	St	23	69.73	68.97	79	55	19	32	10
24 L 050	2F	St	24	72.77	72.00	79	55	19	32	10
25 L 050	2F	St	25	75.80	75.04	83	58	19	32	10
26 L 050	2F	St	26	78.83	78.07	87	58	19	32	12
27 L 050	2F	St	27	81.86	81.10	87	58	19	32	12
28 L 050	2F	St	28	84.89	84.13	91	58	19	32	12
30 L 050	2F	St	30	90.96	90.20	97	70	19	32	12
32 L 050	2F	St	32	97.03	96.26	103	70	19	32	12
33 L 050	2F	St	33	100.05	99.29	106	70	19	32	12
34 L 050	2F	St	34	103.08	102.32	111	70	19	32	12
35 L 050	2F	St	35	106.12	105.35	111	70	19	32	12
36 L 050	2F	St	36	109.15	108.39	115	70	19	32	12
40 L 050	2F	St	40	121.29	120.51	127	70	19	32	12
42 L 050	2F	St	42	127.34	126.58	135	70	19	32	12
44 L 050	2F	St	44	133.40	132.64	140	70	19	32	12
45 L 050	2F	St	45	136.44	135.67	143	70	19	32	12
48 L 050	2F	St	48	145.53	144.77	152	70	19	32	12
50 L 050	4	GG	50	151.60	150.83		70	19	32	14
52 L 050	4	GG	52	157.66	156.90		70	19	32	14
56 L 050	4	GG	56	169.79	169.02		70	19	32	14
57 L 050	4	GG	57	172.82	172.06		70	19	32	14
60 L 050	4	GG	60	181.91	181.15		75	19	42	14
72 L 050	4	GG	72	218.29	217.53		75	19	42	14
84 L 050	4	GG	84	254.68	253.92		75	19	42	14
96 L 050	4	GG	96	291.06	290.30		75	19	42	14

L075

L-3/8" Pitch

L 075 for belt width 3/4"

Part No.	Type	Mat.	Z	Dp	De	Df	Dm	F	L	d
12 L 075	2F	St	12	36.38	35.62	42	24	25.4	38	8
13 L 075	2F	St	13	39.41	38.65	44	28	25.4	38	8
14 L 075	2F	St	14	42.44	41.68	48	28	25.4	38	8
15 L 075	2F	St	15	45.48	44.72	51	34	25.4	38	8
16 L 075	2F	St	16	48.51	47.75	54	36	25.4	38	8
17 L 075	2F	St	17	51.54	50.78	57	36	25.4	38	10
18 L 075	2F	St	18	54.57	53.81	60	40	25.4	38	10
19 L 075	2F	St	19	57.61	56.84	63	40	25.4	38	10
20 L 075	2F	St	20	60.64	59.88	66	40	25.4	38	10
21 L 075	2F	St	21	63.67	62.91	71	45	25.4	38	10
22 L 075	2F	St	22	66.70	65.94	75	45	25.4	38	10
23 L 075	2F	St	23	69.73	68.97	79	55	25.4	38	10
24 L 075	2F	St	24	72.77	72.00	79	55	25.4	38	10
25 L 075	2F	St	25	75.80	75.04	83	58	25.4	38	10
26 L 075	2F	St	26	78.83	78.07	87	58	25.4	38	12
27 L 075	2F	St	27	81.86	81.10	87	58	25.4	38	12
28 L 075	2F	St	28	84.89	84.13	91	58	25.4	38	12
30 L 075	2F	St	30	90.96	90.20	97	70	25.4	38	12
32 L 075	2F	St	32	97.03	96.26	103	70	25.4	38	12
33 L 075	2F	St	33	100.05	99.29	106	70	25.4	38	12
34 L 075	2F	St	34	103.08	102.32	111	70	25.4	38	12
35 L 075	2F	St	35	106.12	105.35	111	70	25.4	38	12
36 L 075	2F	St	36	109.15	108.39	115	70	25.4	38	12
40 L 075	2F	St	40	121.29	120.51	127	70	25.4	38	12
42 L 075	2F	St	42	127.34	126.58	135	70	25.4	38	12
44 L 075	2F	St	44	133.40	132.64	140	70	25.4	38	12
45 L 075	2F	St	45	136.44	135.67	143	70	25.4	38	12
48 L 075	2F	St	48	145.53	144.77	152	70	25.4	38	12
50 L 075	4	GG	50	151.60	150.83		70	25.4	38	14
52 L 075	4	GG	52	157.66	156.90		70	25.4	38	14
56 L 075	4	GG	56	169.79	169.02		70	25.4	38	14
57 L 075	4	GG	57	172.82	172.06		70	25.4	38	14
60 L 075	4	GG	60	181.91	181.15		75	25.4	45	14
72 L 075	4	GG	72	218.29	217.53		75	25.4	45	14
84 L 075	4	GG	84	254.68	253.92		75	25.4	45	14
96 L 075	4	GG	96	291.06	290.30		75	25.4	45	14

Pulleys L100/H100 -Pilot Bore



L100

L-3/8" Pitch

L 100 for belt width 1"

Part No.	Type	Mat.	Z	Dp	De	Df	Dm	F	L	d
12 L 100	2F	St	12	36.38	35.62	42	24	31.8	45	8
13 L 100	2F	St	13	39.41	38.65	44	28	31.8	45	8
14 L 100	2F	St	14	42.44	41.68	48	28	31.8	45	8
15 L 100	2F	St	15	45.48	44.72	51	34	31.8	45	8
16 L 100	2F	St	16	48.51	47.75	54	36	31.8	45	8
17 L 100	2F	St	17	51.54	50.78	57	36	31.8	45	10
18 L 100	2F	St	18	54.57	53.81	60	40	31.8	45	10
19 L 100	2F	St	19	57.61	56.84	63	40	31.8	45	10
20 L 100	2F	St	20	60.64	59.88	66	40	31.8	45	10
21 L 100	2F	St	21	63.67	62.91	71	45	31.8	45	10
22 L 100	2F	St	22	66.70	65.94	75	45	31.8	45	10
23 L 100	2F	St	23	69.73	68.97	79	55	31.8	45	10
24 L 100	2F	St	24	72.77	72.00	79	55	31.8	45	10
25 L 100	2F	St	25	75.80	75.04	83	58	31.8	45	10
26 L 100	2F	St	26	78.83	78.07	87	58	31.8	45	12
27 L 100	2F	St	27	81.86	81.10	87	58	31.8	45	12
28 L 100	2F	St	28	84.89	84.13	91	58	31.8	45	12
30 L 100	2F	St	30	90.96	90.20	97	70	31.8	45	12
32 L 100	2F	St	32	97.03	96.26	103	70	31.8	45	12
33 L 100	2F	St	33	100.05	99.29	106	70	31.8	45	12
34 L 100	2F	St	34	103.08	102.32	111	70	31.8	45	12
35 L 100	2F	St	35	106.12	105.35	111	70	31.8	45	12
36 L 100	2F	St	36	109.15	108.39	115	70	31.8	45	12
40 L 100	2F	St	40	121.29	120.51	127	70	31.8	45	12
42 L 100	2F	St	42	127.34	126.58	135	70	31.8	45	12
44 L 100	2F	St	44	133.40	132.64	140	70	31.8	45	12
45 L 100	2F	St	45	136.44	135.67	143	70	31.8	45	12
48 L 100	2F	St	48	145.53	144.77	152	70	31.8	45	12
50 L 100	4	GG	50	151.60	150.83		70	31.8	45	14
52 L 100	4	GG	52	157.66	156.90		70	31.8	45	14
56 L 100	4	GG	56	169.79	169.02		70	31.8	45	14
57 L 100	4	GG	57	172.82	172.06		70	31.8	45	14
60 L 100	4	GG	60	181.91	181.15		75	31.8	45	14
72 L 100	4	GG	72	218.29	217.53		75	31.8	45	14
84 L 100	4	GG	84	254.68	253.92		75	31.8	45	14
96 L 100	4	GG	96	291.06	290.30		75	31.8	45	14

H100

H-1/2" Pitch

H 100 for belt width 1"

Part No.	Type	Mat.	Z	Dp	De	Df	Dm	F	L	d
14 H 100	2F	St	14	56.59	55.22	63	40	31.8	45	12
15 H 100	2F	St	15	60.64	59.27	70	45	31.8	45	12
16 H 100	2F	St	16	64.67	63.31	70	45	31.8	45	12
17 H 100	2F	St	17	68.72	67.35	75	45	31.8	45	12
18 H 100	2F	St	18	72.77	71.39	79	55	31.8	45	12
19 H 100	2F	St	19	76.81	75.44	83	60	31.8	45	14
20 H 100	2F	St	20	80.85	79.48	87	62	31.8	45	14
21 H 100	2F	St	21	84.89	83.52	91	65	31.8	45	14
22 H 100	2F	St	22	88.93	87.56	94	68	31.8	45	14
23 H 100	2F	St	23	92.98	91.61	102	72	31.8	45	14
24 H 100	2F	St	24	97.03	95.65	102	72	31.8	45	14
25 H 100	2F	St	25	101.06	99.69	112	72	31.8	45	14
26 H 100	2F	St	26	105.11	103.73	112	80	31.8	45	14
27 H 100	2F	St	27	109.15	107.78	120	80	31.8	45	14
28 H 100	2F	St	28	113.18	111.82	120	80	31.8	45	14
29 H 100	2F	St	29	117.23	115.86	120	80	31.8	45	14
30 H 100	2F	St	30	121.29	119.90	120	80	31.8	45	14
32 H 100	2F	St	32	129.36	127.99	128	80	31.8	45	14
33 H 100	2F	St	33	133.40	132.03	135	80	31.8	45	14
34 H 100	2F	St	34	137.45	136.07	142	80	31.8	45	14
35 H 100	2F	St	35	141.49	140.12	150	80	31.8	45	14
36 H 100	2F	St	36	145.54	144.16	158	80	31.8	45	14
38 H 100	2F	St	38	153.62	152.24	158	80	31.8	45	14
40 H 100	2F	St	40	161.70	160.33	168	80	31.8	45	14
44 H 100	2F	GG	44	177.88	176.50	184	80	31.8	50	18
45 H 100	2F	GG	45	181.91	180.54	192	80	31.8	50	18
48 H 100	2F	GG	48	194.03	192.67	200	90	31.8	50	18
50 H 100	4	GG	50	202.13	200.75		90	31.8	50	18
52 H 100	4	GG	52	210.21	208.84		90	31.8	50	18
58 H 100	4	GG	58	234.47	233.09		90	31.8	50	18
60 H 100	4	GG	60	242.55	241.18		100	31.8	50	18
70 H 100	4	GG	70	274.90	281.61		100	31.8	55	18
72 H 100	4	GG	72	282.98	289.69		120	31.8	55	18
84 H 100	4	GG	84	339.57	338.20		120	31.8	55	18
96 H 100	4	GG	96	388.09	386.71		120	31.8	60	18

H150

H-1/2" Pitch

H 150 for belt width 1" 1/2

Part No.	Type	Mat.	Z	Dp	De	Df	Dm	F	L	d
14 H 150	2F	St	14	56.59	55.22	63	40	46	58	18
15 H 150	2F	St	15	60.64	29.27	70	45	46	58	18
16 H 150	2F	St	16	64.67	63.31	70	45	46	58	18
17 H 150	2F	St	17	68.72	67.35	75	45	46	58	18
18 H 150	2F	St	18	72.77	71.39	79	55	46	58	18
19 H 150	2F	St	19	76.81	75.44	83	60	46	58	18
20 H 150	2F	St	20	80.85	79.48	87	62	46	58	18
21 H 150	2F	St	21	84.89	83.52	91	65	46	58	18
22 H 150	2F	St	22	88.93	87.56	94	68	46	58	18
23 H 150	2F	St	23	92.98	91.61	102	72	46	58	18
24 H 150	2F	St	24	97.03	95.65	102	72	46	58	18
25 H 150	2F	St	25	101.06	99.69	112	72	46	58	18
26 H 150	2F	St	26	105.11	103.73	112	80	46	58	18
27 H 150	2F	St	27	109.15	107.78	120	80	46	58	18
28 H 150	2F	St	28	113.18	111.82	120	80	46	58	18
29 H 150	2F	St	29	117.23	115.86	120	80	46	58	18
30 H 150	2F	St	30	121.29	119.90	120	80	46	58	18
32 H 150	2F	St	32	129.36	127.99	128	80	46	58	18
33 H 150	2F	St	33	133.40	132.03	135	80	46	58	18
34 H 150	2F	St	34	137.45	136.07	142	80	46	58	18
35 H 150	2F	St	35	141.49	140.12	150	80	46	58	18
36 H 150	2F	St	36	145.54	144.16	158	80	46	58	18
38 H 150	2F	St	38	153.62	152.24	158	80	46	58	18
40 H 150	2F	St	40	161.70	160.33	168	80	46	58	18
44 H 150	2F	GG	44	177.88	176.50	184	80	46	58	18
45 H 150	2F	GG	45	181.91	180.54	192	80	46	58	18
48 H 150	2F	GG	48	194.03	192.67	200	90	46	65	18
50 H 150	4	GG	50	202.13	200.75		90	46	65	18
52 H 150	4	GG	52	210.21	208.84		90	46	65	18
58 H 150	4	GG	58	234.47	133.09		90	46	65	18
60 H 150	4	GG	60	242.55	241.18		100	46	65	24
70 H 150	4	GG	70	274.90	281.61		100	46	65	24
72 H 150	4	GG	72	282.98	289.69		120	46	65	24
84 H 150	4	GG	84	339.57	338.20		120	46	65	24
96 H 150	4	GG	96	388.09	386.71		120	46	65	24

H200

H-1/2" Pitch

H 200 for belt width 2"

Part No.	Type	Mat.	Z	Dp	De	Df	Dm	F	L	d
14 H 200	2F	St	14	56.59	55.22	63	40	58.7	70	18
15 H 200	2F	St	15	60.64	29.27	70	45	58.7	70	18
16 H 200	2F	St	16	64.67	63.31	70	45	58.7	70	18
17 H 200	2F	St	17	68.72	67.35	75	45	58.7	70	18
18 H 200	2F	St	18	72.77	71.39	79	55	58.7	70	18
19 H 200	2F	St	19	76.81	75.44	83	60	58.7	70	18
20 H 200	2F	St	20	80.85	79.48	87	62	58.7	70	18
21 H 200	2F	St	21	84.89	83.52	91	65	58.7	70	18
22 H 200	2F	St	22	88.93	87.56	94	68	58.7	70	18
23 H 200	2F	St	23	92.98	91.61	102	72	58.7	70	18
24 H 200	2F	St	24	97.03	95.65	102	72	58.7	70	18
25 H 200	2F	St	25	101.06	99.69	112	72	58.7	70	18
26 H 200	2F	St	26	105.11	103.73	112	80	58.7	70	18
27 H 200	2F	St	27	109.15	107.78	120	80	58.7	70	18
28 H 200	2F	St	28	113.18	111.82	120	80	58.7	70	18
29 H 200	2F	St	29	117.23	115.86	120	80	58.7	70	18
30 H 200	2F	St	30	121.29	119.90	120	80	58.7	70	18
32 H 200	2F	St	32	129.36	127.99	128	80	58.7	70	18
33 H 200	2F	St	33	133.40	132.03	135	80	58.7	70	18
34 H 200	2F	St	34	137.45	136.07	142	80	58.7	70	18
35 H 200	2F	St	35	141.49	140.12	150	80	58.7	70	18
36 H 200	2F	St	36	145.54	144.16	158	80	58.7	70	18
38 H 200	2F	St	38	153.62	152.24	158	80	58.7	70	18
40 H 200	2F	St	40	161.70	160.33	168	80	58.7	70	18
44 H 200	2F	GG	44	177.88	176.50	184	80	58.7	70	18
45 H 200	2F	GG	45	181.91	180.54	192	80	58.7	70	18
48 H 200	2F	GG	48	194.03	192.67	200	90	58.7	75	24
50 H 200	4	GG	50	202.13	200.75		90	58.7	75	24
52 H 200	4	GG	52	210.21	208.84		90	58.7	75	24
58 H 200	4	GG	58	234.47	133.09		90	58.7	75	24
60 H 200	4	GG	60	242.55	241.18		100	58.7	75	24
70 H 200	4	GG	70	274.90	281.61		100	58.7	75	28
72 H 200	4	GG	72	282.98	289.69		120	58.7	75	28
84 H 200	4	GG	84	339.57	338.20		120	58.7	75	28
96 H 200	4	GG	96	388.09	386.71		120	58.7	75	28

H300

H-1/2" Pitch

H 300 for belt width 3"

Part No.	Type	Mat.	Z	Dp	De	Df	Dm	F	L	d
14 H 300	2F	St	14	56.59	55.22	63	40	85.7	100	18
15 H 300	2F	St	15	60.64	29.27	70	45	85.7	100	18
16 H 300	2F	St	16	64.67	63.31	70	45	85.7	100	18
17 H 300	2F	St	17	68.72	67.35	75	45	85.7	100	18
18 H 300	2F	St	18	72.77	71.39	79	55	85.7	100	18
19 H 300	2F	St	19	76.81	75.44	83	60	85.7	100	18
20 H 300	2F	St	20	80.85	79.48	87	62	85.7	100	18
21 H 300	2F	St	21	84.89	83.52	91	65	85.7	100	18
22 H 300	2F	St	22	88.93	87.56	94	68	85.7	100	18
23 H 300	2F	St	23	92.98	91.61	102	72	85.7	100	18
24 H 300	2F	St	24	97.03	95.65	102	72	85.7	100	18
25 H 300	2F	St	25	101.06	99.69	112	72	85.7	100	18
26 H 300	2F	St	26	105.11	103.73	112	80	85.7	100	18
27 H 300	2F	St	27	109.15	107.78	120	80	85.7	100	18
28 H 300	2F	St	28	113.18	111.82	120	80	85.7	100	18
30 H 300	2F	St	30	121.29	119.90	120	80	85.7	100	18
32 H 300	2F	St	32	129.36	127.99	128	80	85.7	100	18
33 H 300	2F	St	33	133.40	132.03	135	80	85.7	100	18
34 H 300	2F	St	34	137.45	136.07	142	80	85.7	100	18
35 H 300	2F	St	35	141.49	140.12	150	80	85.7	100	18
36 H 300	2F	St	36	145.54	144.16	158	80	85.7	100	18
38 H 300	2F	St	38	153.62	152.24	158	80	85.7	100	18
40 H 300	2F	St	40	161.70	160.33	168	80	85.7	100	18
44 H 300	2F	GG	44	177.88	176.50	184	80	85.7	100	24
48 H 300	2F	GG	48	194.03	192.67	200	90	85.7	100	24
50 H 300	4	GG	50	202.13	200.75		90	85.7	100	24
58 H 300	4	GG	58	234.47	133.09		90	85.7	100	24
60 H 300	4	GG	60	242.55	241.18		100	85.7	100	24
72 H 300	4	GG	72	282.98	289.69		120	85.7	100	28
84 H 300	4	GG	84	339.57	338.20		120	85.7	100	28
96 H 300	4	GG	96	388.09	386.71		120	85.7	100	28
120 H 300	4	GG	120	485.12	483.72		120	85.7	100	28

XH200

XH-7/8" Pitch

XH 200 for belt width 2"

Part No.	Type	Mat.	Z	Dp	De	Df	Dm	F	L	d
18 XH 200	2F	St	18	127.34	124.55	138	100	65	80	24
19 XH 200	2F	St	19	134.41	131.62	146	100	65	80	24
20 XH 200	2F	St	20	141.49	138.69	154	100	65	80	24
21 XH 200	2F	St	21	148.56	145.77	160	110	65	80	24
22 XH 200	2F	St	22	155.64	152.84	168	110	65	80	24
24 XH 200	2F	St	24	169.79	166.99	183	120	65	80	24
25 XH 200	2F	St	25	176.86	174.07	188	120	65	80	24
26 XH 200	2F	St	26	183.93	181.14	198	120	65	80	24
27 XH 200	2F	St	27	191.01	188.22	200	120	65	80	24
28 XH 200	2F	St	28	198.09	195.29	211	120	56	80	24
30 XH 200	2F	St	30	212.23	209.44	226	120	65	80	24
32 XH 200	2F	St	32	226.38	223.59	240	120	65	80	24
34 XH 200	2F	St	34	240.53	237.74	256	120	65	80	24

XH300

XH-7/8" Pitch

XH 300 for belt width 3"

Part No.	Type	Mat.	Z	Dp	De	Df	Dm	F	L	d
18 XH 300	2F	St	18	127.34	124.55	138	100	92	110	28
19 XH 300	2F	St	19	134.41	131.62	146	100	92	110	28
20 XH 300	2F	St	20	141.49	138.69	154	100	92	110	28
21 XH 300	2F	St	21	148.56	145.77	160	110	92	110	28
22 XH 300	2F	St	22	155.64	152.84	168	110	92	110	28
24 XH 300	2F	St	24	169.79	166.99	183	120	92	110	28
25 XH 300	2F	St	25	176.86	174.07	188	120	92	110	28
26 XH 300	2F	St	26	183.93	181.14	198	120	92	110	28
27 XH 300	2F	St	27	191.01	188.22	200	120	92	110	28
28 XH 300	2F	St	28	198.09	195.29	211	150	92	110	28
30 XH 300	2F	St	30	212.23	209.44	226	150	92	110	28
32 XH 300	2F	St	32	226.38	223.59	240	150	92	110	28
34 XH 300	2F	St	34	240.53	237.74	256	150	92	110	28

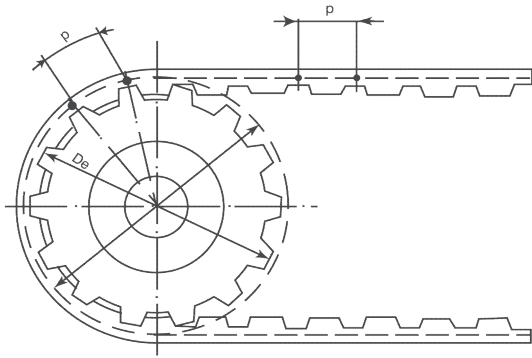

ISO-5294

Fekerman supply L, H series timing pulleys
Pulleys bore type: Taper bushed type

Material selection:

Steel C45 / Aluminum

Surface treatment:

Black oxide, Anodizing, Chromium plating.

Fekerman accept custom made pulleys as per drawings and technology requirement.

Type L H XH

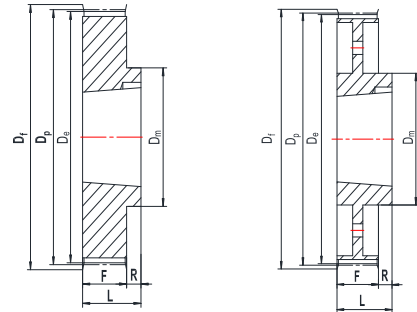

10F

11F

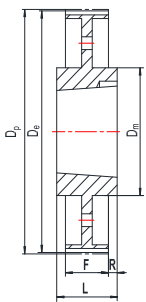

13

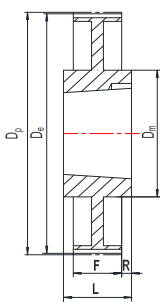

14

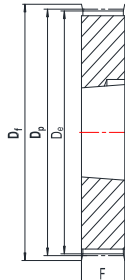

15F

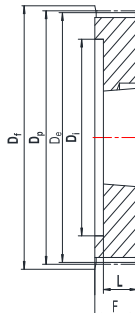

16F

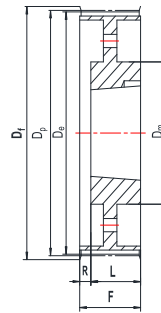

17F

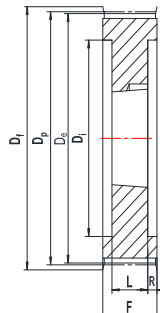

18F

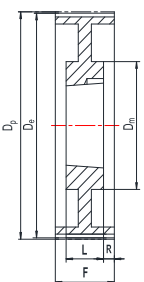

19

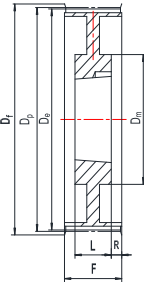

19F

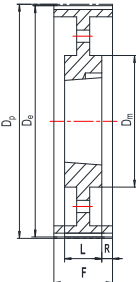

20

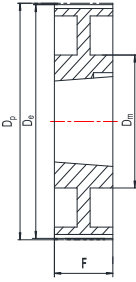

21

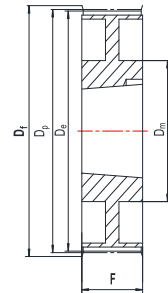

21F

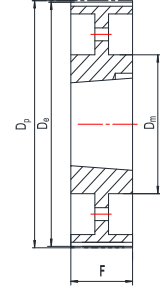

22

Pulleys L050/L075/L100 -Taper Bore



L050

L-3/8" Pitch

L 050 for belt width 1/2"

Part No.	Type	Z	Bush	Dp	De	Df	Dm	F	L	R
TB 18 L 050	10F	18	1108	54.57	53.81	60	44	19	22	3
TB 19 L 050	10F	19	1108	57.16	56.84	63	44	19	22	3
TB 20 L 050	10F	20	1108	60.64	59.88	66	48	19	22	3
TB 21 L 050	10F	21	1108	63.67	62.91	71	48	19	22	3
TB 22 L 050	10F	22	1108	66.70	65.94	75	51	19	22	3
TB 23 L 050	10F	23	1108	69.73	68.97	79	54	19	22	3
TB 24 L 050	10F	24	1108	72.77	72.00	79	54	19	22	3
TB 25 L 050	10F	25	1108	75.80	75.04	83	56	19	22	3
TB 26 L 050	10F	26	1108	78.83	78.07	87	60	19	22	3
TB 27 L 050	10F	27	1108	81.86	81.10	87	62	19	22	3
TB 28 L 050	10F	28	1108	84.89	84.13	91	65	19	22	3
TB 30 L 050	10F	30	1108	90.96	90.20	97	70	19	22	3
TB 32 L 050	10F	32	1108	97.02	96.26	103	74	19	22	3
TB 36 L 050	10F	36	1108	109.15	108.39	115	85	19	22	3
TB 40 L 050	10F	40	1610	121.28	120.51	127	97	19	25	6
TB 48 L 050	11F	48	1610	145.53	144.77	152	88	19	25	6
TB 60 L 050	13	60	1610	181.91	181.15		92	19	25	3
TB 72 L 050	14	72	1610	218.30	217.53		92	19	25	3
TB 84 L 050	14	84	1610	254.68	253.90		92	19	25	3
TB 96 L 050	14	96	2012	291.06	290.30		106	19	32	6.5
TB 120 L 050	14	120	2012	363.83	363.07		106	19	32	6.5

L075

L-3/8" Pitch

L 075 for belt width 3/4"

Part No.	Type	Z	Bush	Dp	De	Df	Dm	F	L	R
TB 18 L 075	15F	18	1108	54.57	53.81	60		25	25	
TB 19 L 075	15F	19	1108	57.16	56.84	63		25	25	
TB 20 L 075	15F	20	1108	60.64	59.88	66		25	25	
TB 21 L 075	15F	21	1108	63.67	62.91	71		25	25	
TB 22 L 075	15F	22	1108	66.70	65.94	75		25	25	
TB 23 L 075	15F	23	1108	69.73	68.97	79		25	25	
TB 24 L 075	15F	24	1108	72.77	72.00	79		25	25	
TB 25 L 075	15F	25	1108	75.80	75.04	83		25	25	
TB 26 L 075	15F	26	1108	78.83	78.07	87		25	25	
TB 27 L 075	15F	27	1108	81.86	81.10	87		25	25	
TB 28 L 075	15F	28	1108	84.89	84.13	91		25	25	
TB 30 L 075	15F	30	1108	90.96	90.20	97		25	25	
TB 32 L 075	15F	32	1108	97.02	96.26	103		25	25	
TB 36 L 075	15F	36	1610	109.15	108.39	115		25	25	
TB 40 L 075	15F	40	1610	121.28	120.51	127		25	25	
TB 48 L 075	21F	48	1610	145.53	144.77	152	92	25	25	
TB 60 L 075	21	60	1610	181.91	181.15		92	25	25	
TB 72 L 075	22	72	1610	218.30	217.53		92	25	25	
TB 84 L 075	14	84	2012	254.68	253.90		106	25	32	3.5
TB 96 L 075	14	96	2012	291.06	290.30		106	25	32	3.5
TB 120 L 075	14	120	2012	363.83	363.07		106	25	32	3.5

L100

L-3/8" Pitch

L 100 for belt width 1"

Part No.	Type	Z	Bush	Dp	De	Df	Dm	F	L	R
TB 18 L 100	16F	18	1108	54.57	53.81	60		32	22	10
TB 19 L 100	16F	19	1108	57.16	56.84	63		32	22	10
TB 20 L 100	16F	20	1108	60.64	59.88	66		32	22	10
TB 21 L 100	16F	21	1108	63.67	62.91	71		32	22	10
TB 22 L 100	16F	22	1108	66.70	65.94	75		32	22	10
TB 23 L 100	16F	23	1108	69.73	68.97	79		32	22	10
TB 24 L 100	16F	24	1108	72.77	72.00	79		32	22	10
TB 25 L 100	16F	25	1108	75.80	75.04	83		32	22	10
TB 26 L 100	16F	26	1108	78.83	78.07	87		32	22	10
TB 27 L 100	16F	27	1108	81.86	81.10	87		32	22	10
TB 28 L 100	16F	28	1108	84.89	84.13	91		32	25	10
TB 30 L 100	16F	30	1210	90.96	90.20	97		32	25	7
TB 32 L 100	16F	32	1210	97.02	96.26	103		32	25	7
TB 36 L 100	16F	36	1610	109.15	108.39	115		32	25	7
TB 40 L 100	16F	40	1610	121.28	120.51	127		32	25	7
TB 48 L 100	17F	48	1610	145.53	144.77	152	92	32	25	7
TB 60 L 100	19	60	1610	181.91	181.15		92	32	25	3.5
TB 72 L 100	22	72	2012	218.30	217.53		92	32	32	
TB 84 L 100	22	84	2012	254.68	253.90		106	32	32	
TB 96 L 100	22	96	2012	291.06	290.30		106	32	32	
TB 120 L 100	22	120	2012	363.83	363.07		106	32	32	

Pulleys H100/H150/H200 -Taper Bore



H100

H-1/2" Pitch

H 100 for belt width 1"

Part No.	Type	Z	Bush	Dp	De	Df	Dm	F	L	R
TB 16 H 100	16F	16	1108	64.68	63.31	71		32	22	10
TB 18 H 100	16F	18	1210	72.77	71.39	79		32	25	7
TB 19 H 100	16F	19	1210	76.81	75.44	83		32	25	7
TB 20 H 100	16F	20	1210	80.55	79.48	87		32	25	7
TB 21 H 100	16F	21	1210	84.89	83.52	91		32	25	7
TB 22 H 100	16F	22	1210	88.94	87.56	93		32	25	7
TB 23 H 100	16F	23	1610	92.98	91.61	97		32	25	7
TB 24 H 100	16F	24	1610	97.02	95.65	103		32	25	7
TB 25 H 100	16F	25	1610	101.06	99.69	106		32	25	7
TB 26 H 100	16F	26	1610	105.11	103.73	111		32	25	7
TB 27 H 100	16F	27	1610	109.05	107.78	115		32	25	7
TB 28 H 100	16F	28	1610	113.19	111.82	119		32	25	7
TB 30 H 100	16F	30	1610	121.28	119.80	127		32	25	7
TB 32 H 100	17F	32	1610	129.36	127.99	135	90	32	25	7
TB 36 H 100	17F	36	1610	145.53	144.16	152	92	32	25	7
TB 40 H 100	17F	40	1610	161.70	160.33	168	92	32	25	7
TB 44 H 100	21F	44	2012	177.87	176.50	184	106	32	32	
TB 48 H 100	21F	48	2012	194.04	192.67	200	106	32	32	
TB 60 H 100	20	60	2012	242.55	241.18		106	32	32	1
TB 72 H 100	20	72	2012	291.06	289.69		106	32	32	1
TB 84 H 100	20	84	2012	339.57	338.20		106	32	32	1
TB 96 H 100	14	96	2517	388.08	386.71		119	32	45	5.5
TB 120H 100	14	120	2517	485.10	483.73		119	32	45	5.5

H150

H-1/2" Pitch

H 150 for belt width 1" 1/2

Part No.	Type	Z	Bush	Dp	De	Df	Dm	F	L	R
TB 18 H 150	16F	18	1210	72.77	71.39	79		45	25	20
TB 19 H 150	16F	19	1210	76.81	75.44	83		45	25	20
TB 20 H 150	16F	20	1210	80.55	79.48	87		45	25	20
TB 21 H 150	16F	21	1210	84.89	83.52	91		45	25	20
TB 22 H 150	16F	22	1210	88.94	87.56	93		45	25	20
TB 23 H 150	16F	23	1610	92.98	91.61	97		45	25	20
TB 24 H 150	16F	24	1610	97.02	95.65	103		45	25	20
TB 25 H 150	16F	25	1610	101.06	99.69	106		45	25	20
TB 26 H 150	16F	26	1610	105.11	103.73	111		45	25	20
TB 27 H 150	16F	27	1610	109.05	107.78	115		45	25	20
TB 28 H 150	16F	28	1610	113.19	111.82	119		45	25	20
TB 30 H 150	16F	30	1610	121.28	119.80	127		45	25	20
TB 32 H 150	17F	32	1610	129.36	127.99	135	90	45	25	20
TB 36 H 150	17F	36	1610	145.53	144.16	152	92	45	25	20
TB 40 H 150	17F	40	1610	161.70	160.33	168	92	45	25	20
TB 44 H 150	17F	44	2012	177.87	176.50	184	106	45	32	13
TB 48 H 150	17F	48	2012	194.04	192.67	200	106	45	32	13
TB 60 H 150	20	60	2012	242.55	241.18		106	45	32	7
TB 72 H 150	20	72	2012	291.06	289.69		106	45	32	7
TB 84 H 150	20	84	2012	339.57	338.20		106	45	32	7
TB 96 H 150	20	96	2517	388.08	386.71		119	45	45	5.5

H200

H-1/2" Pitch

H 200 for belt width 2"

Part No.	Type	Z	Bush	Dp	De	Df	Dm	F	L	R
TB 18 H 200	16F	18	1210	72.77	71.39	79		58	25	33
TB 19 H 200	16F	19	1210	76.81	75.44	83		58	25	33
TB 20 H 200	16F	20	1210	80.55	79.48	87		58	25	33
TB 21 H 200	16F	21	1210	84.89	83.52	91		58	25	33
TB 22 H 200	16F	22	1210	88.94	87.56	93		58	25	33
TB 23 H 200	16F	23	1610	92.98	91.61	97		58	25	33
TB 24 H 200	16F	24	1610	97.02	95.65	103		58	25	33
TB 25 H 200	16F	25	1610	101.06	99.69	106		58	25	33
TB 26 H 200	16F	26	1610	105.11	103.73	111		58	25	33
TB 27 H 200	16F	27	1610	109.05	107.78	115		58	25	33
TB 28 H 200	16F	28	1610	113.19	111.82	119		58	25	33
TB 30 H 200	16F	30	1610	121.28	119.80	127		58	25	33
TB 32 H 200	16F	32	2012	129.36	127.99	135		58	32	26
TB 36 H 200	17F	36	2012	145.53	144.16	152	102	58	32	26
TB 40 H 200	17F	40	2012	161.70	160.33	168	106	58	32	26
TB 44 H 200	17F	44	2012	177.87	176.50	184	106	58	32	26
TB 48 H 200	17F	48	2517	194.04	192.67	200	119	58	45	13
TB 60 H 200	20	60	2517	242.55	241.18		119	58	45	7.5
TB 72 H 200	20	72	2517	291.06	289.69		119	58	45	7.5
TB 84 H 200	20	84	2517	339.57	338.20		119	58	45	7.5
TB 96 H 200	20	96	2517	388.08	386.71		119	58	45	7.5

H300

H-1/2" Pitch

H 300 for belt width 3"

Part No.	Type	Z	Bush	Dp	De	Df	Dm	F	L	R
TB 20 H 300	18F	20	1615	80.55	79.48	87		84	38	23
TB 21 H 300	18F	21	1615	84.89	83.52	91		84	38	23
TB 22 H 300	18F	22	1615	88.94	87.56	93		84	38	23
TB 23 H 300	18F	23	1615	92.98	91.61	97		84	38	23
TB 24 H 300	18F	24	1615	97.02	95.65	103		84	38	23
TB 25 H 300	18F	25	1615	101.06	99.69	106		84	38	23
TB 26 H 300	18F	26	1615	105.11	103.73	111		84	38	23
TB 27 H 300	18F	27	2012	109.05	107.78	115		84	32	26
TB 28 H 300	18F	28	2012	113.19	111.82	119		84	32	26
TB 30 H 300	18F	30	2012	121.28	119.80	127		84	32	26
TB 32 H 300	18F	32	2517	129.36	127.99	135		84	45	19.5
TB 36 H 300	18F	36	2517	145.53	144.16	152		84	45	19.5
TB 40 H 300	18F	40	2517	161.70	160.33	168		84	45	19.5
TB 44 H 300	19F	44	2517	177.87	176.50	184	119	84	45	20.5
TB 48 H 300	19F	48	2517	194.04	192.67	200	119	84	45	20.5
TB 60 H 300	20	60	2517	242.55	241.18		119	84	45	20.5
TB 72 H 300	20	72	2517	291.06	289.69		119	84	45	20.5
TB 84 H 300	20	84	2517	339.57	338.20		119	84	45	20.5
TB 96 H 300	20	96	3030	388.08	386.71		150	84	76	5